



Finest Quality

Union Special®

INDUSTRIAL SEWING EQUIPMENT

Instructions and Illustrated Parts List

CATALOG NO.

194-10-GR

First Edition

STYLES

160-20

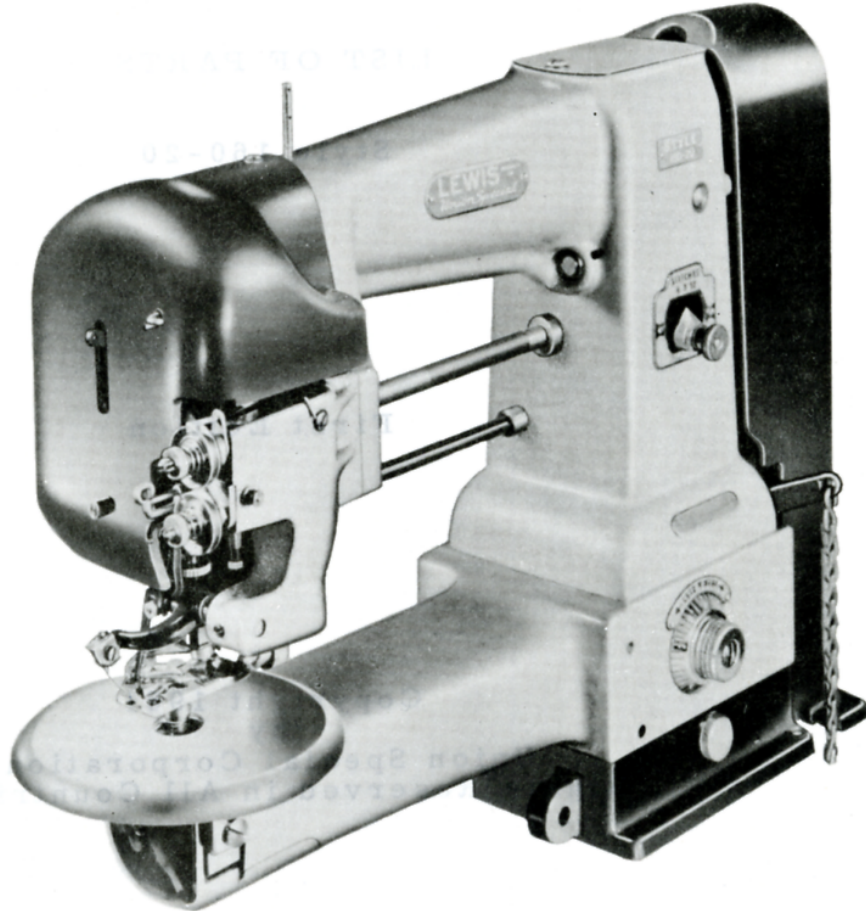

LEWIS
CLASS 160-20
SINGLE THREAD BLINDSTITCH
SPOT TACKING MACHINE

10/19/06



Manual No. 194-10-GR Adjusting Instruction Illustrated parts for 160-20 Series Machines

First Edition Copyright 2006
By
Union Special Corporation Rights Reserved In All Countries
Printed in U.S.A. October 2006

PREFACE

This parts manual has been prepared to guide you while adjusting the 160-20 Series machines.

This manual explains in detail the proper setting for each of the components related to forming the stitch and completing the functions of the machine. Illustrations are used to show the adjustments and reference letters are used to point out specific items discussed.

Careful attention to the instructions for operating and adjusting these machines will enable you to maintain the superior performance and reliability designed and built into every Union Special machine.

Adjustments are presented in sequence so that a logical progression is accomplished. Some adjustments performed out of sequence may have an adverse effect on the function of the other related parts.

This manual has been comprised on the basis of available information. Changes in design and/or improvements may incorporate a slight modification of configuration in illustrations or part numbers.

On the following pages will be found illustrations and terminology used in describing the adjustments for the 160-20 Series machines.

FOREWORD

All parts in Style 160-20 are made by precision methods insuring complete interchangeability.

It is our constant aim to furnish carefully prepared information which will enable the customer to secure all possible advantages from the use of UNION SPECIAL machines. The following pages contain valuable operating and adjusting data, and illustrate and describe the parts for Style 160-20.

Union Special representatives will be found in all manufacturing centers, to cooperate with you to plan and estimate requirements.

UNION SPECIAL CORPORATION

IDENTIFICATION OF MACHINES

Each UNION SPECIAL LEWIS machine carries a style number, which, on this machine, is stamped in the style plate on the right side of the column.

The serial number of each machine is stamped in the column on the right side below the stitch indicator.

APPLICATION OF CATALOG

This catalog applies specifically to Style 160-20. All references to direction, such as right and left, front and back, etc., are taken from the operator's position while seated at the machine.

The operating direction of the pulley is counterclockwise.

DESCRIPTION OF MACHINE

Style 160-20 is a single thread blindstitch spot tacking machine. Curved needle. Automatic thread cutting device. Calibrated stitch selector for 6, 8 or 12 stitches. Dial adjusted stitch penetration. Automatic stitching cycle. Fully enclosed arm. Work space behind needle 9 inches. Two pedal operation. For attaching labels to sweaters, neckties, jackets, and similar articles. Also used for tacking operations on trouser cuffs, linings of suit coats, uniforms, and trouser waistbands. Can be used on light, medium or heavy knitted or woven materials.

The machine will be fitted with presser foot No. 405-555 and plunger No. 26-173 suitable for medium weight work; unless otherwise specified.

Other combinations available, are as follows:

<u>Presser Foot</u>	<u>Plunger</u>	<u>Operation</u>
405-554	26-170	For tacking light materials.
405-554 L	26-170	For tacking light materials.
405-554 L	26-174	For tacking fabric labels.
405-555 H	26-173	For tacking heavy materials.
405-555 H	26-172	For tacking extra heavy materials.

OILING

The machine should be oiled twice daily, before the morning and afternoon starts. Use a good grade of straight mineral oil of a Saybolt Viscosity of 90 to 125 seconds at 100° Fahrenheit.

Most of the oiling places on the machine are readily identifiable because of the fact they are painted red. However, reference to the oiling diagram Fig. 21 on Page 13 will be beneficial.

Please note that it will be necessary to tip the machine back and to remove the work plate, head cover, and cylinder end cover to reach some of the oiling places.

Also note that there is a label on the pulley which reads "Grease Here". A tube of grease is furnished with the machine, and periodically the plug screw in the pulley should be removed and the grease level checked and replenished if required. The greasing place is indicated by the letter "A" in the diagram. All other places shown are oiled.

Tubes of grease may be ordered under part No. 28604 P.

SPEED

The recommended operating speed of this machine is 1200 R.P.M.

NEEDLES

Each needle has both a type and size number. The type number denotes the kind of shank, point, length, groove, finish and other details. The size number, stamped on the needle shank, denotes largest diameter of blade, measured midway between shank and eye. Collectively, type and size number represent the complete symbol, which is given on the label of all needles packaged and sold by UNION SPECIAL. The recommended needle for Style 160-20 is Type 29 BD-100/040. It has a blade diameter of .040 inch (1.0mm). It is also available in the following sizes:

<u>Needle Type</u>	<u>Inches</u>	<u>Size</u>	<u>Millimeters</u>
29 BD-065/025	.025		.65
29 BD-075/029	.029		.75
29 BD-090/036	.036		.90
29 BD-110/044	.044		1.10
29 BD-140/054	.054		1.40

Selection of proper needle size is determined by size of thread and weight of material used. Thread should pass freely through the needle eye in order to produce a good stitch formation.

To have needle orders promptly and accurately filled, an empty container, a sample needle, or the Type number should be forwarded. Use the description on the label. A complete order would read "100 Needles, Type 29 BD-100/040".

CHANGING NEEDLES

When changing needle, make sure that it is inserted in the needle carrier as far as it will go, and tighten clamp screw completely.

Immediately discard and needle which may have a hooked or blunt point, as improper needle penetration will result.

THREADING

To thread the machine, turn pulley in operating direction until the needle carrier is in its highest position, and thread in accordance with diagram Fig. 20 on Page 11.

ADJUSTING

CAUTION! Do not run the Electro Drive during the following adjusting operations until ready to sew.

The 160-20 machine is equipped with a cycling mechanism, which, with one pressure on the operating treadle, produces 6, 8 or 12 stitches, and automatically stops.

In the following instructions, reference is made to "the machine in stop position".

This position is that which is shown in Fig. 1 with the stop motion disc and pawl against the plunger (A).

To release the machine from stop position so that it may be manually operated, depress the operating treadle, and turn the pulley and stop motion disc in required direction.

ADJUST STOP MOTION CLUTCH

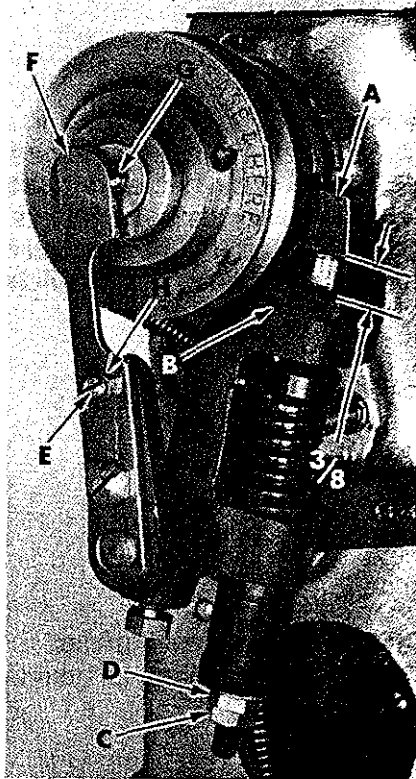

Fig. 1

With machine in stop position, stop motion plunger (A, Fig. 1) should be set so that there is $\frac{3}{8}$ inch between the bottom of plunger and plunger lever bracket (B). Loosen the lower lock nut (C) and adjust upper nut (D) to obtain this setting. Lock lower nut. Adjust screw (E) in cam lever (F) so that there is $\frac{1}{32}$ inch clearance between ball (G) and thin section of lever when the pulley is pressed in toward machine. Lock screw with nut (H).

Remove head cover. With machine in stop position, remove gear (A, Fig. 2) from main shaft. Turn head main shaft gear (B) until the take-up lever (C) is at its highest point. Replace main shaft gear (A) with spot screw (D) in line with timing slot in main shaft. Tighten screws.

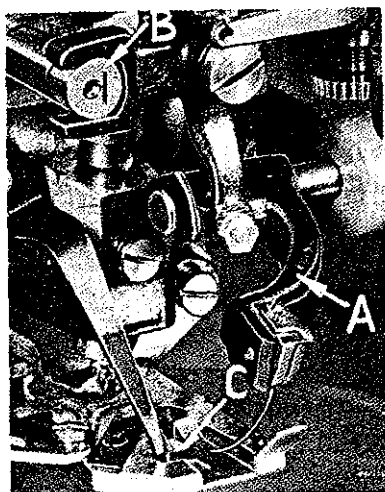

Fig. 3

TIMING NEEDLE

With machine in stop position, loosen screws in the needle drive crank (E, Fig. 2), and turn crank until needle carrier (A, Fig. 3) is at highest point of travel, and tighten screws in crank.

At this point, the slot in needle vibrating cam (B) should be on right side of cam center, and in a vertical position. To make this adjustment, loosen accessible set screw (A, Fig. 4) in gear (B), disengage stop motion lever, and rotate pulley until second set screw in gear (B) is accessible. Loosen this screw and return to stop position. With a screwdriver, align slot in vibrating cam as per above. Tighten gear set screws.

Turn pulley in operating direction until needle enters needle guide slot in presser foot on left side. There should be .012 inch clearance between left side of needle blade and presser foot needle guide slot. Lightly tap the needle vibrating crank adjusting lug (A, Fig. 5) to right or left to secure this adjustment. In the photograph the needle vibrating crank has been removed for clarity.

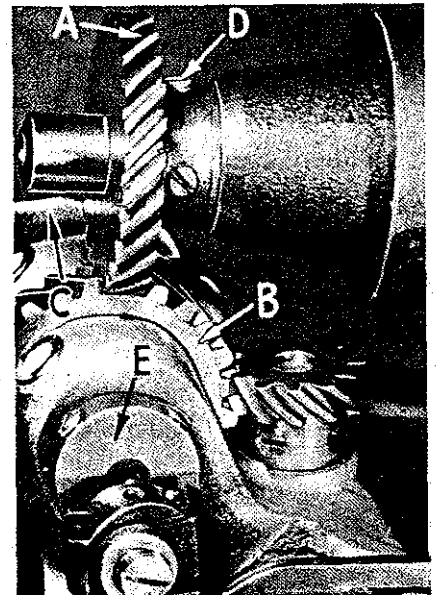

Fig. 2

TIMING THE LOOPER

Loosen set screws in the looper drive shaft gear (A, Fig. 6). Turn pulley in operating direction until needle has reached the forward end of its left side travel and returned $\frac{3}{32}$ inch. Turn looper and its shaft so that the point of looper is over center of needle, and tighten set screws in gear (A). Lower point of looper as close to the needle as possible without deflecting the needle. Loosen screw (A, Fig. 7) to make this adjustment.

ADJUST STROKE OF NEEDLE

Turn pulley in operating direction until point of looper is directly over center of needle as needle is returning on its left stroke. The back of needle eye should now be 1/16 inch from looper point. If adjustment is required at this point, loosen the two locknuts (B, Fig. 5) on ball joint connecting rod (C) and turn rod to secure this setting.

ADJUST NEEDLE HEIGHT

A new eccentric needle carrier stud, No. 17-175, replaces No. 1708 L and has been developed to enable the needle height to be adjusted more closely, so that it does not strike the needle guide too far forward.

To check adjustment of needle height, turn the pulley in operating direction until screw (A, Fig. 7) in looper driving gear (B) points to right of machine. At this point the needle point should be approximately 1/16 inch past the front edge of needle guide (C, Fig. 3) on presser foot, and just contacting needle guide.

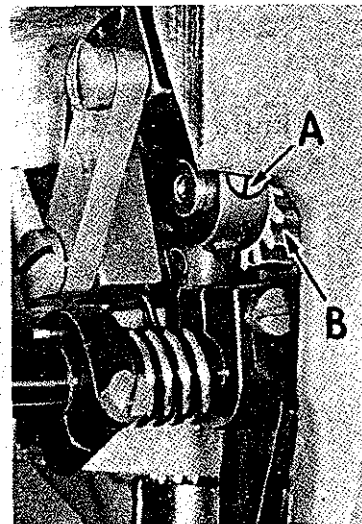

Fig. 4

If needle point strikes needle guard too far forward of the 1/16 inch dimension, or too hard, an adjustment can be made by loosening set screw (C, Fig. 7) and inserting a screwdriver in slot of needle carrier eccentric shaft (D). Turn eccentric shaft as required to bring needle carrier up or down and tighten set screw. After making this adjustment check and be sure there is no play between needle and needle guide when needle point is over center of plunger No. 26-173. After making this adjustment it may be necessary to reset the adjustment under "Adjust Stroke of Needle" and "Timing the Looper".

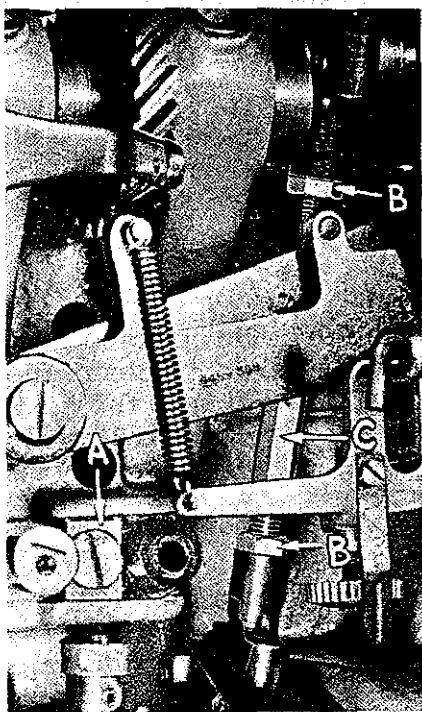

Fig. 5

shaft (E) clockwise until bottom of work clamp (A, Fig. 9) is 5/32 inch above plunger bearing block. Tighten clamp screws (A, Fig. 8) and re-engage spring (B).

ADJUST PLUNGER

With machine in stop position, tilt machine on side, pull penetration dial out, and turn clockwise as far as it will go. Loosen locknut (F, Fig. 8), and adjust screw (G) until space between plunger block (A, Fig. 10) and crank (B) is 1/64 inch. Lock nut (F, Fig. 8) securely. Tip machine back, engage clutch, and turn pulley in operating direction until point of looper is over center of needle. Loosen locknut (A, Fig. 11) and adjust plunger up or down by means of nut (B) until point of looper just contacts needle. Lock nut (A) securely.

ADJUST WORK CLAMP

The distance the work clamp opens for insertion of work is set at the factory and usually does not have to be adjusted. Should it become necessary to do so, the proper setting may be obtained as follows:

Tip machine on its side and loosen clamp screws (A, Fig. 8). Disengage spring (B) from crank roll. Depress lever (C) until it rests against its stop pin (D). Turn plunger

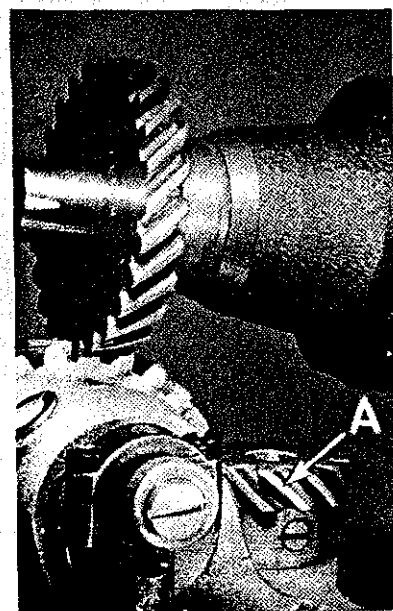

Fig. 6

ADJUST THREAD CUTTING FINGER AND THREAD WIPER

The purpose of the thread cutting finger is to carry the thread across the knife edge. The purpose of the thread wiper is to keep the thread taut during the cutting operation and to remove or wipe the remaining needle thread from the sewing area. In order to function properly, the thread cutting finger should start its motion before the thread wiper. The adjustment of these members are accomplished in the following manner.

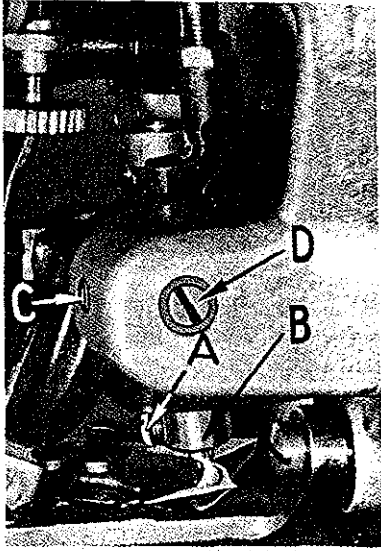

Fig. 7

Rotate the spring collar (A, Fig. 12), and tighten binding screw (B) when collar has been turned about 45° from zero tension.

With thread cutting finger (A, Fig. 13) at the back of its travel, set the trimmer lever (C, Fig. 12) so that it is over the center of the ball (D) from front

to back.

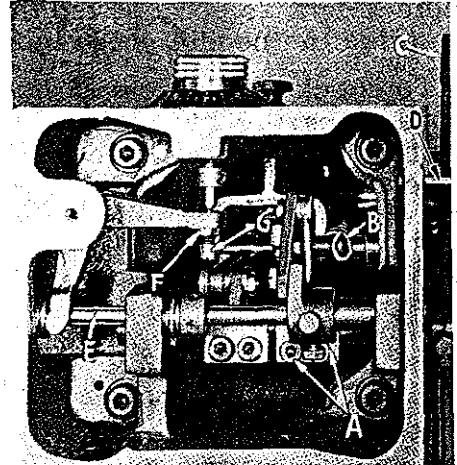

Fig. 8

Check position of thread wiper crank (A, Fig. 14) through the access hole at the back of the machine. With the machine in stop position, this crank should be horizontal or slightly below to the right. If the crank is not in this position, loosen the two set screws (B, Fig. 13) in the thread wiper finger (C). Return to the back of the machine, and loosen the two screws (B, Fig. 14) in the cam plate (C), and move the crank (A) to the desired position. Now, slightly tighten one screw in the thread wiper finger (C, Fig. 13).

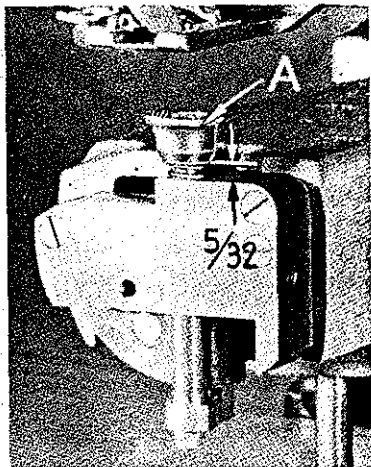

Fig. 9

The screw stud in the crank (D, Fig. 14) should rest against the lower edge of the cam lobe (E) and against surface of the cam below the lobe. To do this, insert a screw driver through the opening in the cam plate, and using it as a lever, apply downward pressure to the cam while tightening the two screws (B) and maintaining the cam plate (C) in its proper

position to hold the crank (A) horizontally as previously described. Now, return to the thread wiper finger (C, Fig. 13), and check its position.

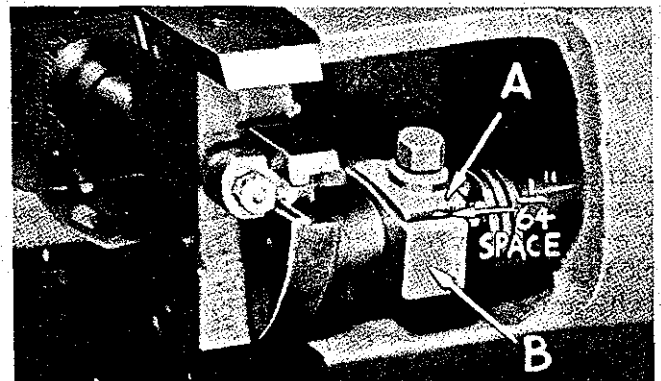

Fig. 10

ADJUST THREAD CUTTING FINGER AND THREAD WIPER (Continued)

There should be a slight amount of side play between the finger and the presser foot. If the finger is tight against the presser foot, loosen screw (B), and move finger slightly, then, re-check previous settings, and tighten both screws (B) in wiper finger securely.

ADJUST THREAD CUTTING KNIFE

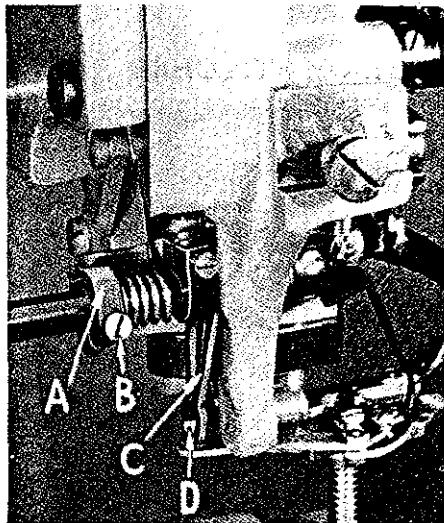

Fig. 12

turn the stop motion disc opposite to direction of rotation one half turn. Then, reverse direction, and turn until stop motion disc pawl (C) comes to rest against the plunger (A).

Check the pull-off lever plunger (B, Fig. 15) to be sure it operates freely. Looking down into the head of the machine under the front main shaft bearing, loosen the clamp screw in driving crank (A, Fig. 17), and manually raise the pull-off lever

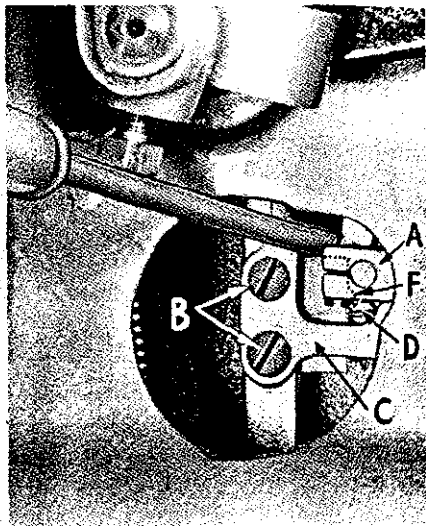

Fig. 14

The thread cutting knife (D, Fig. 13) should be set forward in its slot enough to provide proper cutting action.

ADJUST THREAD PULL-OFF LEVER

The pull-off lever (A, Fig. 15) is set correctly when it snaps off the plunger (B) as the stop motion plunger (A, Fig. 16) comes to an abrupt stop against the stop motion disc (B) when operating machine by hand.

To adjust, re-
lease machine from
its stop motion, and

manually raise the pull-off lever (A, Fig. 15) and plunger operating lever (C). Then, carefully lower the pull-off lever (A) until it just drops off the point of the plunger (B). Then, carefully tighten clamp screw in driving crank (A, Fig. 17).

Re-check operation of pull-off lever manually as described in paragraph one, and re-set if required.

ADJUST AUTOMATIC TENSION

Engage clutch and turn pulley in operating direction until the needle is on its return stroke and its point is 9/16 inch to the front of the center of the plunger.

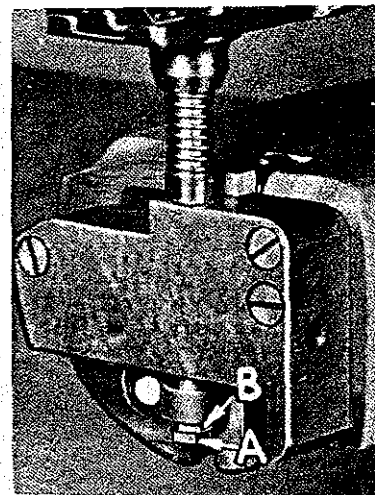

Fig. 11

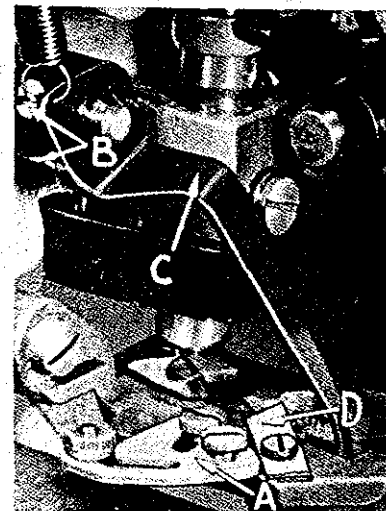

Fig. 13

ADJUST AUTOMATIC TENSION (Continued)

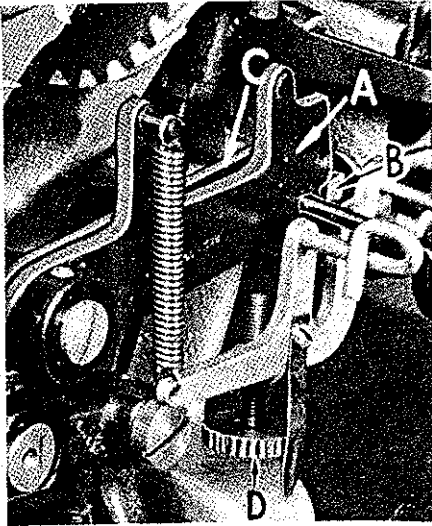

Fig. 15

The automatic thread tension lever (A, Fig. 18) should now begin to part the tension discs. This adjustment is made by manually depressing the lever (A) until its projection begins to part the discs, loosening screw (B), and moving the eccentric sleeve (C) to maintain the lever (A) in the desired position. This is an approximate setting only, and may have to be changed slightly to compensate for varying thicknesses of thread.

SELECTING NUMBER OF STITCHES

To set stitch selector to desired number of stitches, either 6, 8, or 12, operate machine until red arrow on cam shaft (A, Fig. 19) coincides with red line (B) on bushing. Pull out stitch selector knob (C), and move sideways until indicator point lines up with desired number of stitches, and release selector knob.

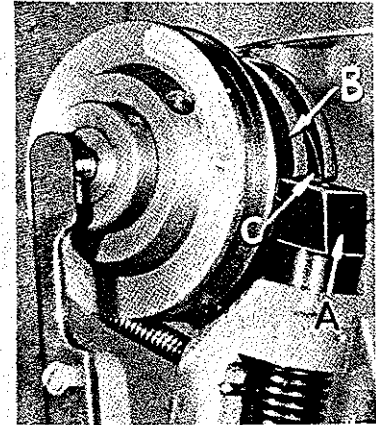

Fig. 16

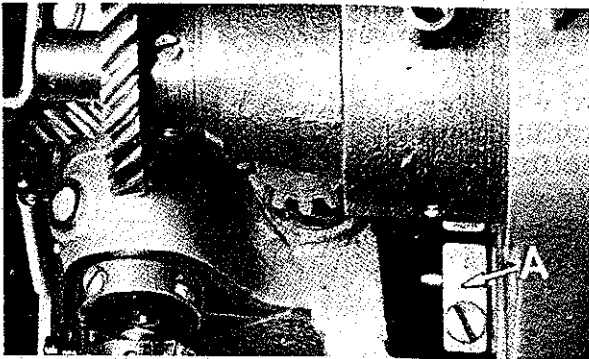

Fig. 17

STARTING TO OPERATE

Thread as per threading diagram (Fig. 20). Depress work clamp treadle, insert work over work clamp, and release treadle. Depress and release starting treadle. CAUTION! Do not hold starting treadle down as the

machine will not stop automatically at the end of the stitch number cycle for which it is set. The red line on the right side of the presser foot is a guide line for the material being tacked.

ADJUSTMENT FOR NEEDLE THREAD LOOP

It may be necessary to increase or decrease the size of the needle thread loop for various sizes of thread. This adjustment is made by advancing needle drive crank (D, Fig. 18) slightly for larger loop, retarding slightly for smaller loop.

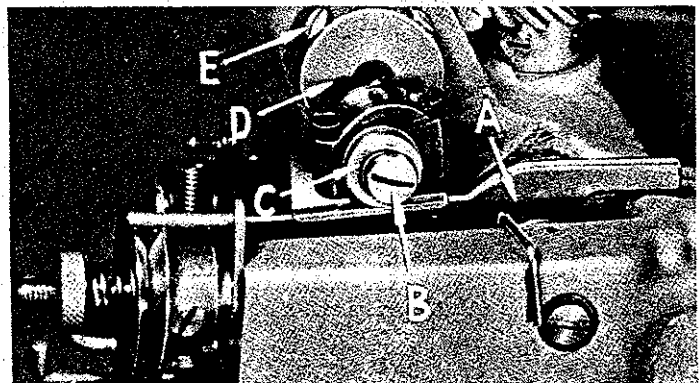

Fig. 18

Loosen set screws (E) to make this adjustment.

THREAD TENSIONS

Adjust thread tensions to secure proper appearance of tack. A relatively strong pressure is carried on both tension assemblies, but may have to be varied to suit different threads.

ADJUSTMENT FOR LENGTH OF STARTING THREAD

If too much thread tail shows on completed tack, turn pull-off lever control screw (D, Fig. 15) clockwise to reduce length of tail. If starting thread is too short, causing loss of stitches, turn the control screw counterclockwise until slight amount of tail shows.

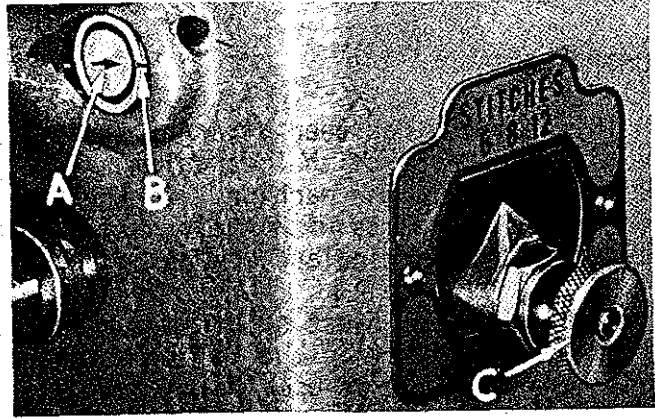

Fig. 19

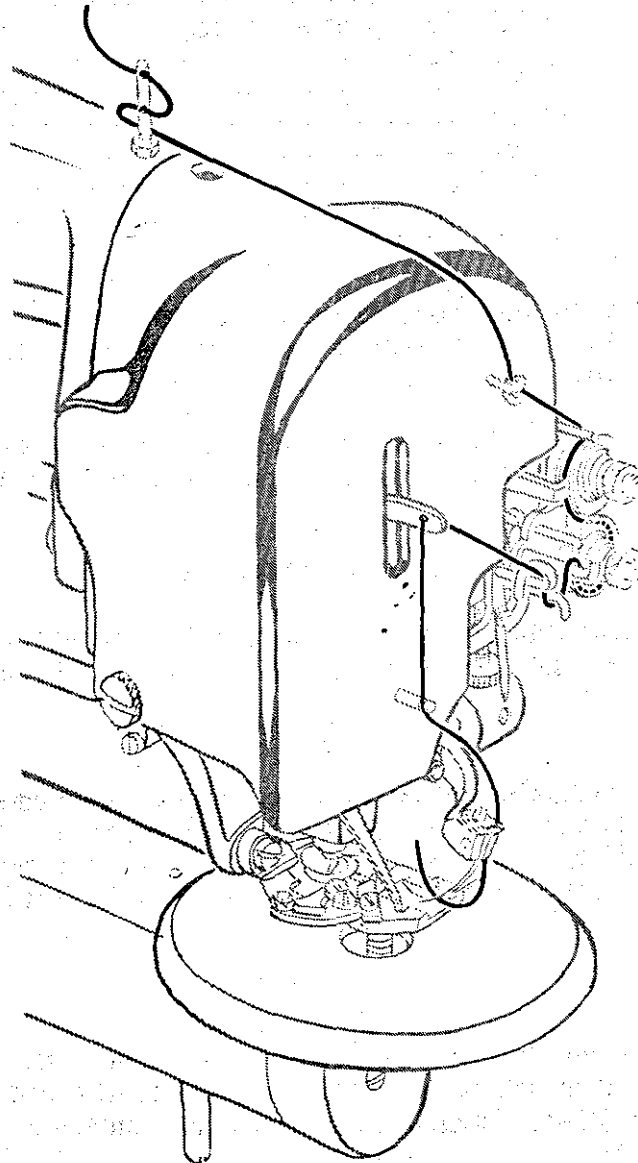

Fig. 20

ORDERING REPAIR PARTS

ILLUSTRATIONS

This catalog has been arranged to simplify ordering repair parts. Exploded views of various sections of the mechanism are shown so that the parts may be seen in their actual position in the machine. On the page opposite the illustration will be found a listing of the parts with their part numbers, description and the number of pieces required in the particular view being shown.

Numbers in the first column are reference numbers only, and merely indicate the position of that part in the illustration. Reference number should never be used in ordering parts. Always use the part number listed in the second column.

Component parts of sub-assemblies which can be furnished for repairs are indicated by indenting their descriptions under the description of the main sub-assembly. Example:

25	447-128	Needle Carrier Connecting Rod, complete-----	1
26	4124-57	Ball Joint, upper, complete -----	1
27	18-391	Screw -----	2
28	1012 L	Nut -----	1
29	71-95	Rod -----	1
30	869 L	Nut -----	1
31	447-23	Ball Joint, lower, complete -----	1
32	18-391	Screw -----	2

It will be noted in the above example that the balls and the straps are not listed. The reason is that replacement of these parts individually is not recommended, so the complete sub-assembly should be ordered.

At the back of the book will be found a numerical index of all the parts shown in this book. This will facilitate locating the illustration and description when only the part number is known.

IDENTIFYING PARTS

Where the construction permits, each part is stamped with its part number. Part numbers represent the same part, regardless of catalog in which they appear.

USE GENUINE REPAIR PARTS

Success in the operation of these machines can be secured only with genuine repair parts as furnished by the Union Special Corporation, its subsidiaries and authorized distributors. They are designed according to the most approved scientific principles, and are made with utmost precision. Maximum efficiency and durability are assured.

TERMS

Prices are net cash and subject to change without notice. All shipments are forwarded f.o.b. shipping point. Parcel Post shipments are insured unless otherwise directed. A charge is made to cover postage and insurance.

OILING DIAGRAM

Oil all places indicated except at "A" which requires grease. Refer to oiling instructions on Page 4.

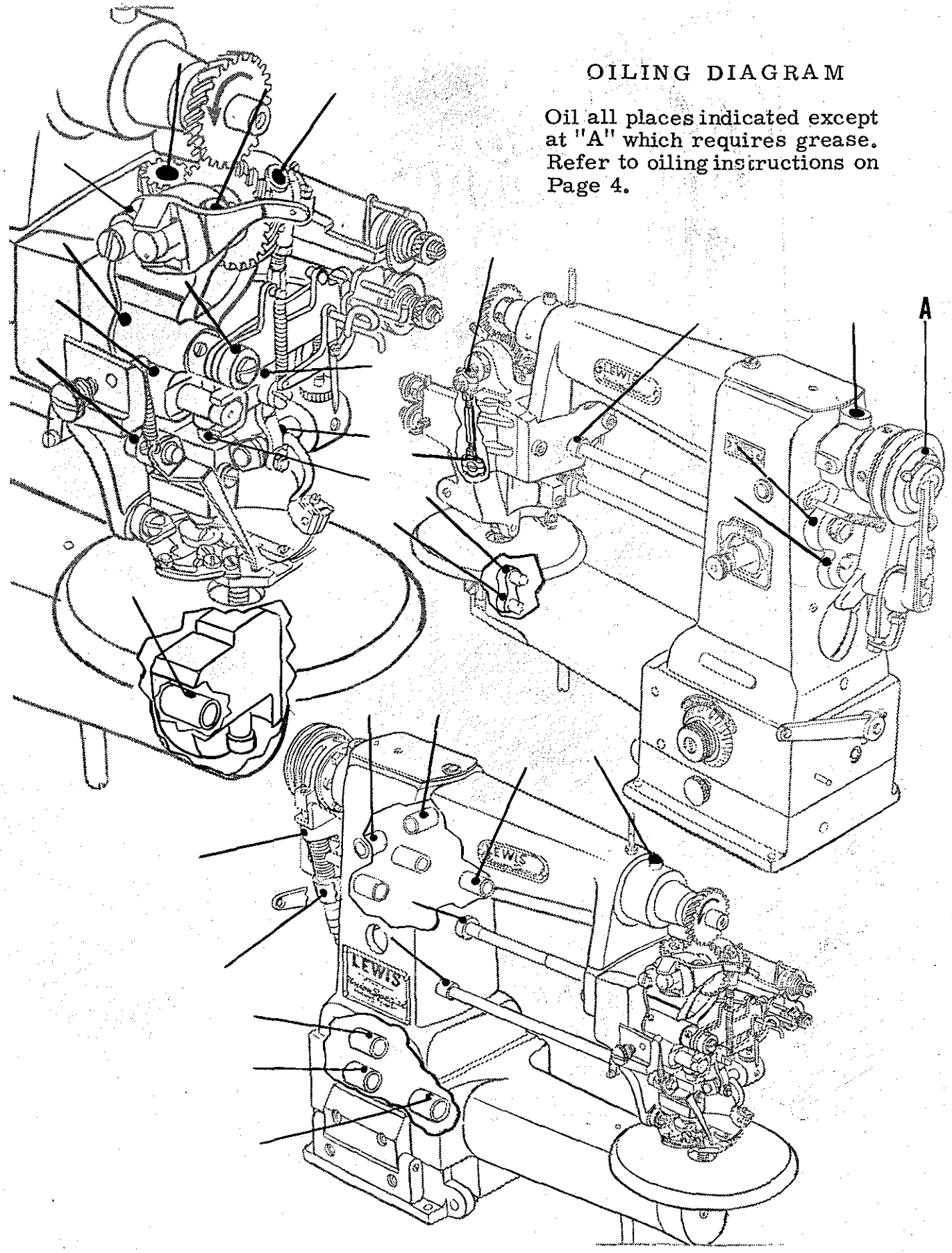
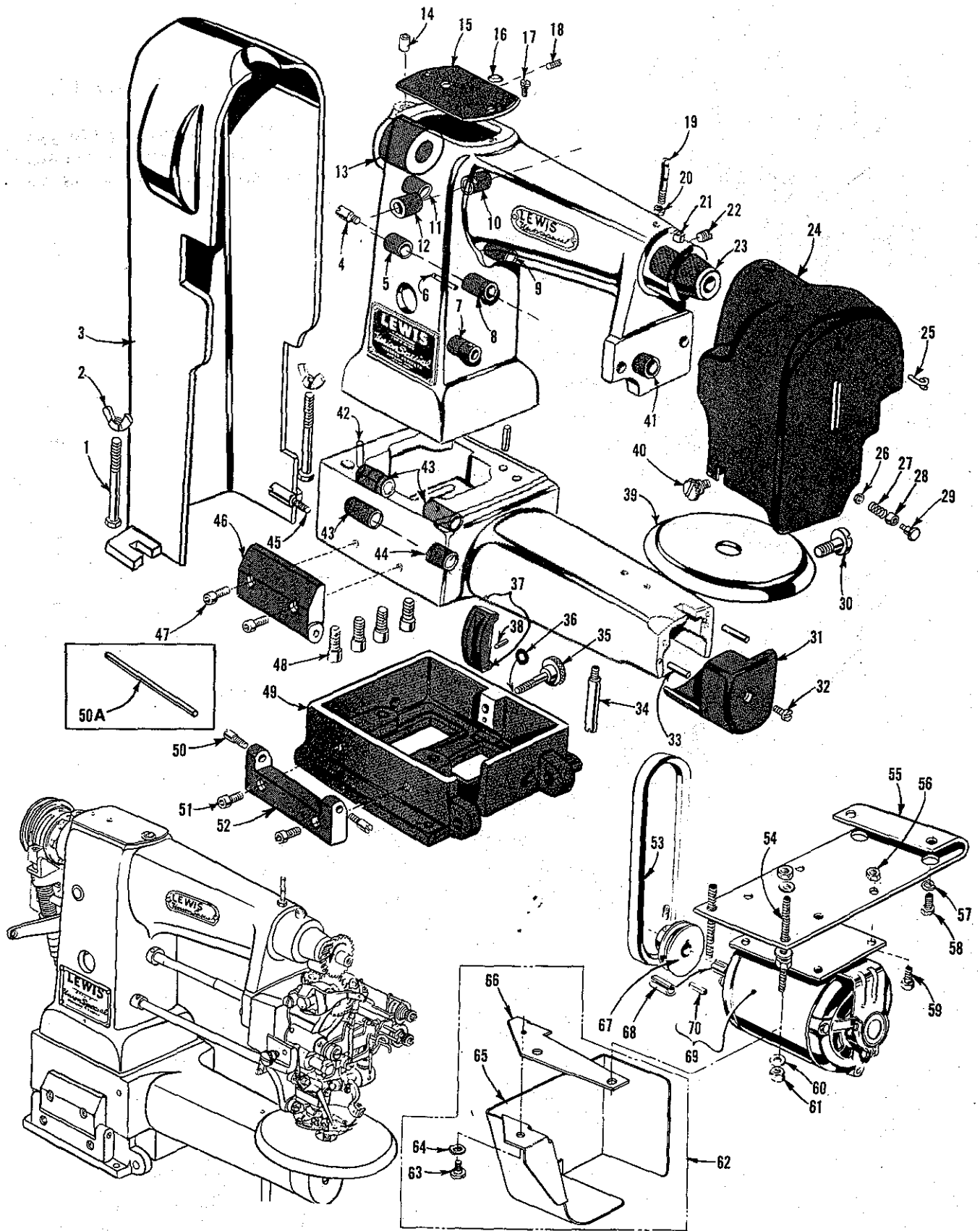

Fig. 21



MAIN FRAME, ARM, BASE AND COVERS

<u>Ref. No.</u>	<u>Part No.</u>	<u>Description</u>	<u>Amt. Req.</u>
1	18-993	Screw -----	2
2	20-130	Wing Nut -----	2
3	32-265	Pulley and Stop Motion Cover -----	1
4	18-979	Stop Screw -----	1
5	16-326	Stop Motion Lever Shaft Bushing, back -----	1
6	22-275	Plunger Restoring Spring Pin -----	1
7	16-338	Trimmer Shaft Bushing, back -----	1
8	16-344	Stop Motion Lever Shaft Bushing, middle -----	1
9	16-343	Cam Shaft Bushing, front -----	1
10	16-324	Jack Shaft Bushing, right -----	1
11	16-325	Cam Shaft Bushing, back -----	1
12	16-323	Jack Shaft Bushing, left -----	1
13	16-333	Main Shaft Bushing, back -----	1
14	125-23	Oil Cup -----	1
15	1219 L	Arm Cover Plate -----	1
16	1221 L	Spring Washer -----	1
17	1220 L	Screw -----	1
18	1195 L	Set Screw, for No. 16-333 -----	1
19	41-55	Thread Guide Pin -----	1
20	1160 L	Nut -----	1
21	61-76	Oil Tube -----	1
22	CS320-1/2	Set Screw, for No. 1196 L -----	1
23	1196 L	Main Shaft Bushing, front -----	1
24	32-266	Head Cover -----	1
25	147-10	Thread Guide -----	1
26	1311 L	Nut -----	1
27	21-381	Thread Snubber Spring -----	1
28	70-77	Thread Snubber Sleeve -----	1
29	17-176	Thread Snubber Stud -----	1
30	LS395	Screw, for No. 4-134 -----	1
31	32-275	Cylinder Base End Cover -----	1
32	CS313	Screw -----	1
33	667 B-20	Dowel Pin -----	2
34	17-167	Cylinder Base Supporting Stud -----	1
35	18-1030	Sub-Base Locking Latch Adjusting Screw -----	1
36	40-139	Washer -----	1
37	GR-51-26	Sub-Base Locking Latch -----	1
38	GR-22C214-2	Sub-Base Locking Latch Pin -----	1
39	4-134	Work Support Plate -----	1
40	854 L	Screw -----	1
41	16-345	Stop Motion Lever Shaft Bushing, front -----	1
42	22-148	Locating Dowel Pin -----	2
43	16-354	Plunger and Jack Shaft Bushing -----	3
44	16-379	Plunger Shaft Bushing -----	1
45	22845 D	Stop Pin -----	1
46	50-263 L	Cylinder Base Hinge Bracket -----	1
47	18-998	Screw -----	2
48	18-1045	Screw -----	4
49	3-91	Sub-Base -----	1
*50	18-959	Hinge Bracket Pivot Screw -----	2
*50A	14-508	Hinge Bracket Pivot Shaft -----	1
51	18-998	Screw -----	2
52	50-262	Sub-Base Hinge Bracket -----	1
53	21261 M-440	"V" Belt, 44 inch (1117.6 mm) outside circumference -----	1
54	21697 AF-32	Motor Hanger Adjusting Stud -----	2
55	21697 AE	Motor Hanger -----	1
56	651-20	Nut -----	4
57	652 A-20	Lock Washer -----	4
58	22642 K-32	Screw -----	2
59	22642 K-48	Screw -----	4
60	652-20	Washer -----	8
61	651-20	Nut -----	6
62	408-150	Belt Guard Assembly -----	1
63	1220 L	Shoulder Screw -----	1
64	12957 E	Spring Washer -----	1
65	8-150	Belt Guard -----	1
66	50-319	Belt Guard Bracket -----	1
67	28602 AS-18	Electro Drive Pulley, 2 1/4 inches (57.1 mm) working diameter -----	1
	28602 AS-22	Electro Drive Pulley, 2 3/4 inches (69.8 mm) working diameter -----	1
68	660-615	Split Steel Bushing -----	1
69	28741 H	Electric Motor, 1 phase, 60 Hz., 110 volts -----	1
	28742 AG	Electric Motor, 3 phase, 50/60 Hz., 208/220/380/440 volts -----	1
70	108-9	Key -----	1

*On new machines two No. 18-959 will be replaced by one No. 14-508.

NOTE: Ref. Nos. 53 thru 70 are optional accessories.

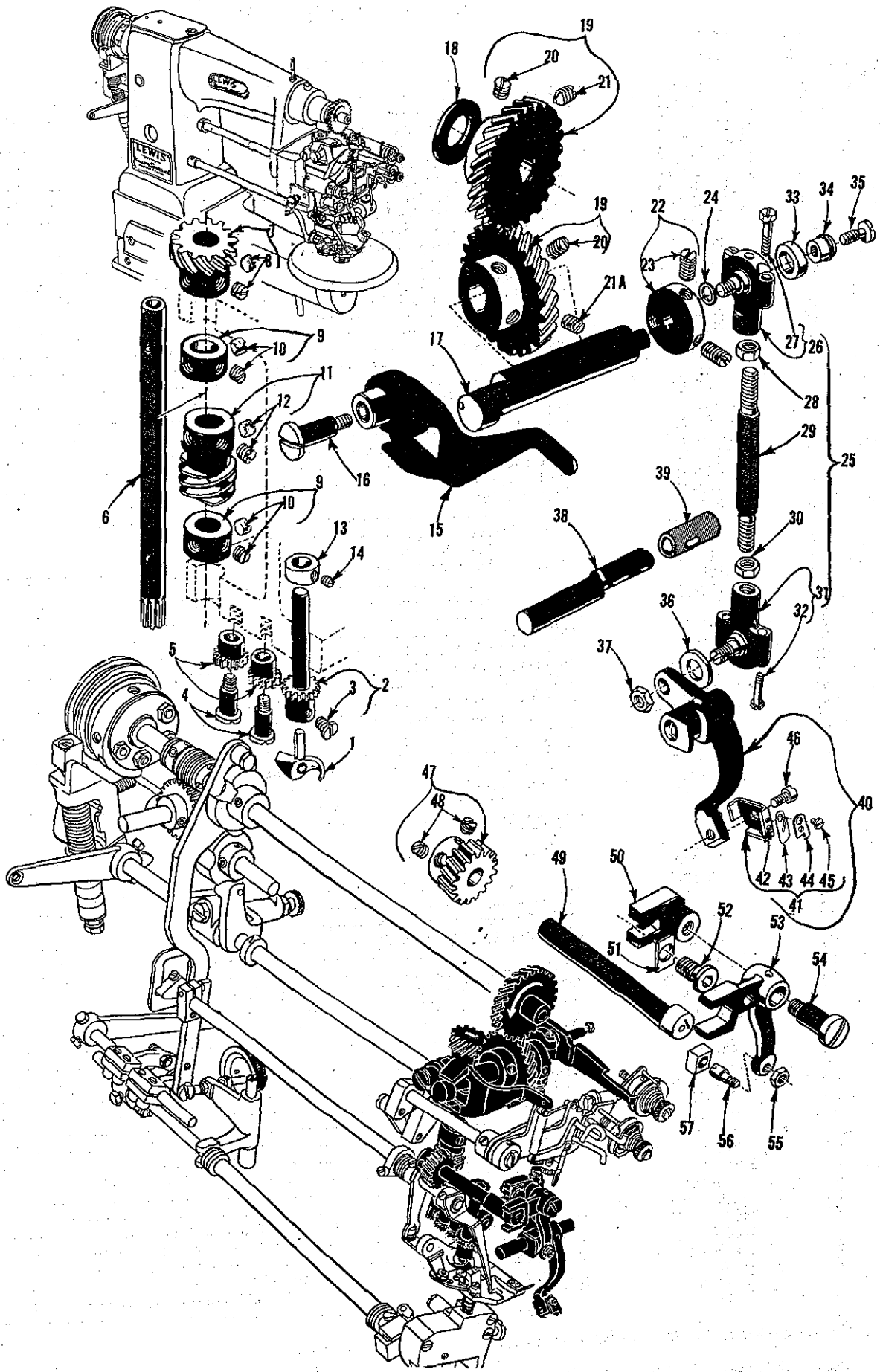

NEEDLE AND LOOPER DRIVING MECHANISM

Ref. No.	Part No.	Description	Amt. Req.
1	36-19	Looper	1
2	27-186	Looper Driving Gear	1
3	18-949	Screw	1
4	18-619	Screw	2
5	27-187	Idler Gear	2
6	14-447	Looper Timing Shaft	1
7	27-188	Looper Timing Shaft Driving Gear	1
8	1025 L	Set Screw	2
9	1027 L	Collar	2
10	1029-L	Set Screw	2
11	1762 L	Needle Carrier Vibrating Worm Gear	1
12	1025 L	Set Screw	2
13	39-95	Collar	1
14	1022 L	Set Screw	1
15	445-366	Thread Take-up Lever, complete	1
16	18-994	Screw	1
17	14-448	Head Main Shaft	1
18	40-17	Washer	1
19	1804 L	Main Shaft Drive and Driven Gears	2
20	1005 L	Set Screw	1
21	1203 L	Spot Screw	1
*21A	1005 L	Set Screw	1
22	48-154	Head Main Shaft Crank	1
23	18-624	Set Screw	2
24	51242 M	Washer	1
25	447-128	Needle Carrier Connecting Rod, complete	1
26	4124-57	Ball Joint, upper, complete	1
27	18-391	Screw	2
28	1012 L	Nut	1
29	71-95	Rod	1
30	869 L	Nut	1
31	447-23	Ball Joint, lower, complete	1
32	18-391	Screw	2
33	35-26	Eccentric Sleeve Roll	1
34	70-61	Eccentric Sleeve	1
35	CS327	Screw	1
36	40-57	Washer	1
37	1012 L	Nut	1
38	17-175	Needle Carrier Eccentric Stud	1
39	16-382	Slip Bushing	1
40	118-34	Needle Carrier, complete	1
41	1432 AL	Needle Clamp, complete	1
42	1420 L	Pin	1
43	41-28	Thread Guide Plate	1
44	1016 L	Thread Guide	1
45	1036 L	Screw	1
46	1014 L	Screw	1
47	1763 L	Needle Carrier Vibrating Gear	1
48	1025 L	Set Screw	2
49	1718 L	Needle Carrier Crank Shaft, marked "B"	1
50	1717 L	Needle Carrier Crank Adjusting Lug	1
51	1719 L	Rectangular Washer	1
52	18-1094	Screw	1
53	46-146	Needle Carrier Vibrating Crank	1
54	782 L	Screw	1
55	1311 L	Nut	1
56	17-137	Needle Carrier Vibrating Crank Slide Block Stud	1
57	69-18	Needle Carrier Vibrating Crank Slide Block	1

* One No. 1203 L Spot Screw will be replaced by one No. 1005 L on Head Main Shaft Driven Gear.

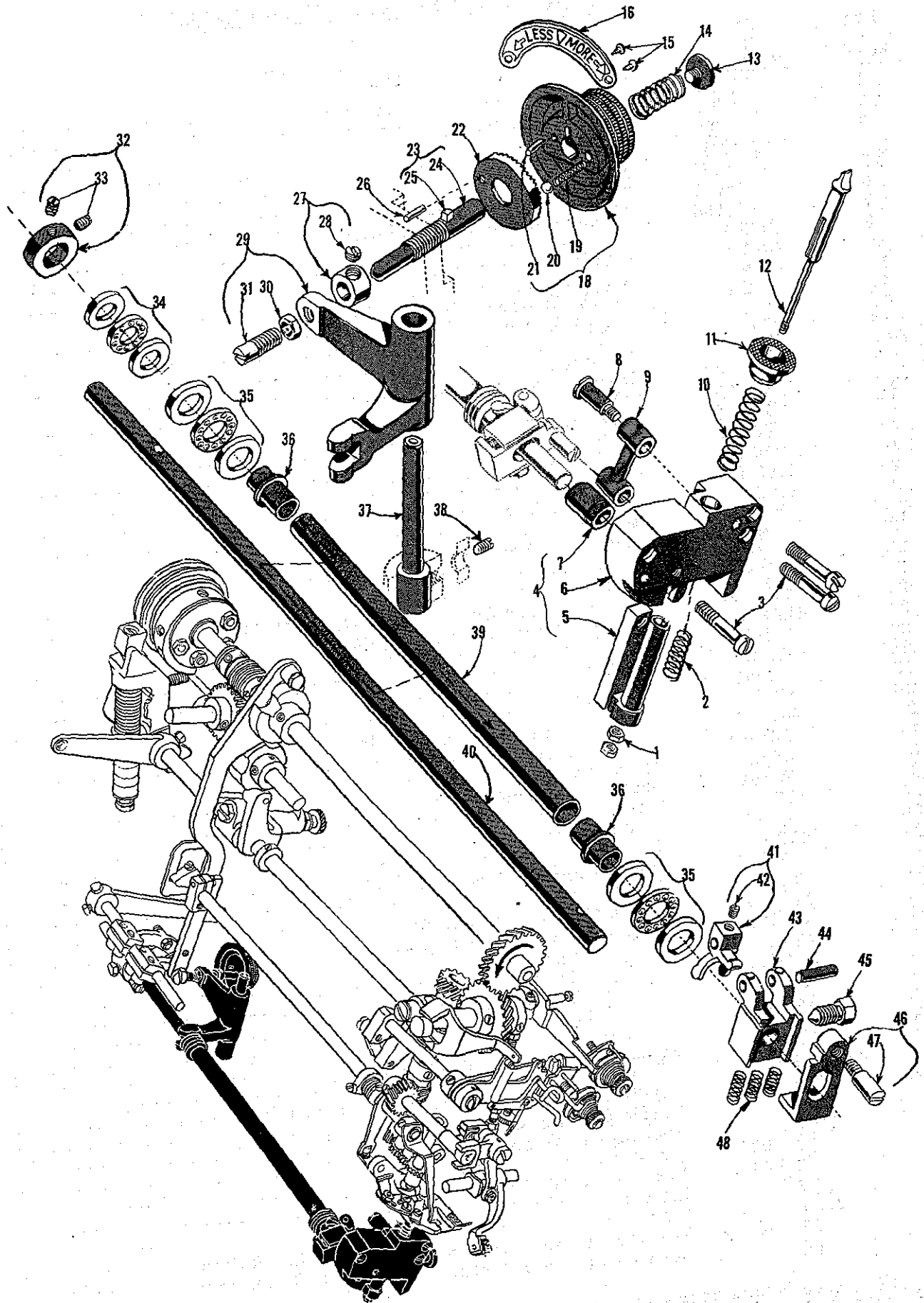

PLUNGER AND PLUNGER REGULATING MECHANISM

<u>Ref. No.</u>	<u>Part No.</u>	<u>Description</u>	<u>Amt. Req.</u>
1	1311 L	Nut-----	2
2	21-383	Plunger Spring-----	1
3	1279 L	Screw-----	3
4	4115-134-2	Plunger Bearing Block, complete-----	1
5	4121-5	Plunger Frame and Barrel Assembly-----	1
6	115-122	Plunger Bearing Block-----	1
7	16-352	Bushing-----	1
8	1306 L	Screw-----	1
9	1304 L	Plunger Frame Link-----	1
10	21-402	Cloth Clamp Spring-----	1
11	30-65	Cloth Clamp-----	1
12		Plunger, See Page No. 29-----	1
13	18-1028	Screw-----	1
14	21-404	Spring-----	1
15	18-768	Drive Screw-----	2
16	110-323	Regulating Plate-----	1
18	GR-4149-30	Plunger Regulating Knob Assembly-----	1
19	21-237	Spring-----	1
20	79-31	Ball-----	1
21	GR-22C214-4	Stop Pin-----	1
22	44-301	Disc Notch Plate-----	1
23	418-1026	Plunger Regulating Screw, complete-----	1
24	18-1026	Regulating Screw-----	1
25	22-296	Pin-----	1
26	GR-22C214-4	Stop Pin-----	1
27	1173 L	Collar-----	1
28	1137 L	Set Screw-----	1
29	48-166	Plunger Regulating Bell Crank, large-----	1
30	20-34	Nut-----	1
31	1192 L	Set Screw-----	1
32	1027 L	Collar-----	1
33	1029 L	Set Screw-----	2
*34	478-11	Ball Bearing, complete-----	1
35	478-23	Ball Bearing, complete-----	2
36	16-366	Plunger Regulating Crank Shaft Bushing-----	2
37	14-472	Plunger Regulating Crank Shaft-----	1
38	1005 L	Set Screw-----	1
39	61-82	Plunger Regulating Crank Shaft Tube-----	1
40	14-446	Plunger Shaft-----	1
41	48-165	Plunger Regulating Bell Crank, small-----	1
42	18-416	Set Screw-----	1
43	115-139	Plunger Regulating Block-----	1
44	22-297	Small Bell Crank Pin-----	1
45	1298 L	Set Screw-----	1
46	48-168	Plunger Crank-----	1
47	18-1027	Screw-----	1
48	21-403	Plunger Crank Spring-----	3

* Not used on new machines.

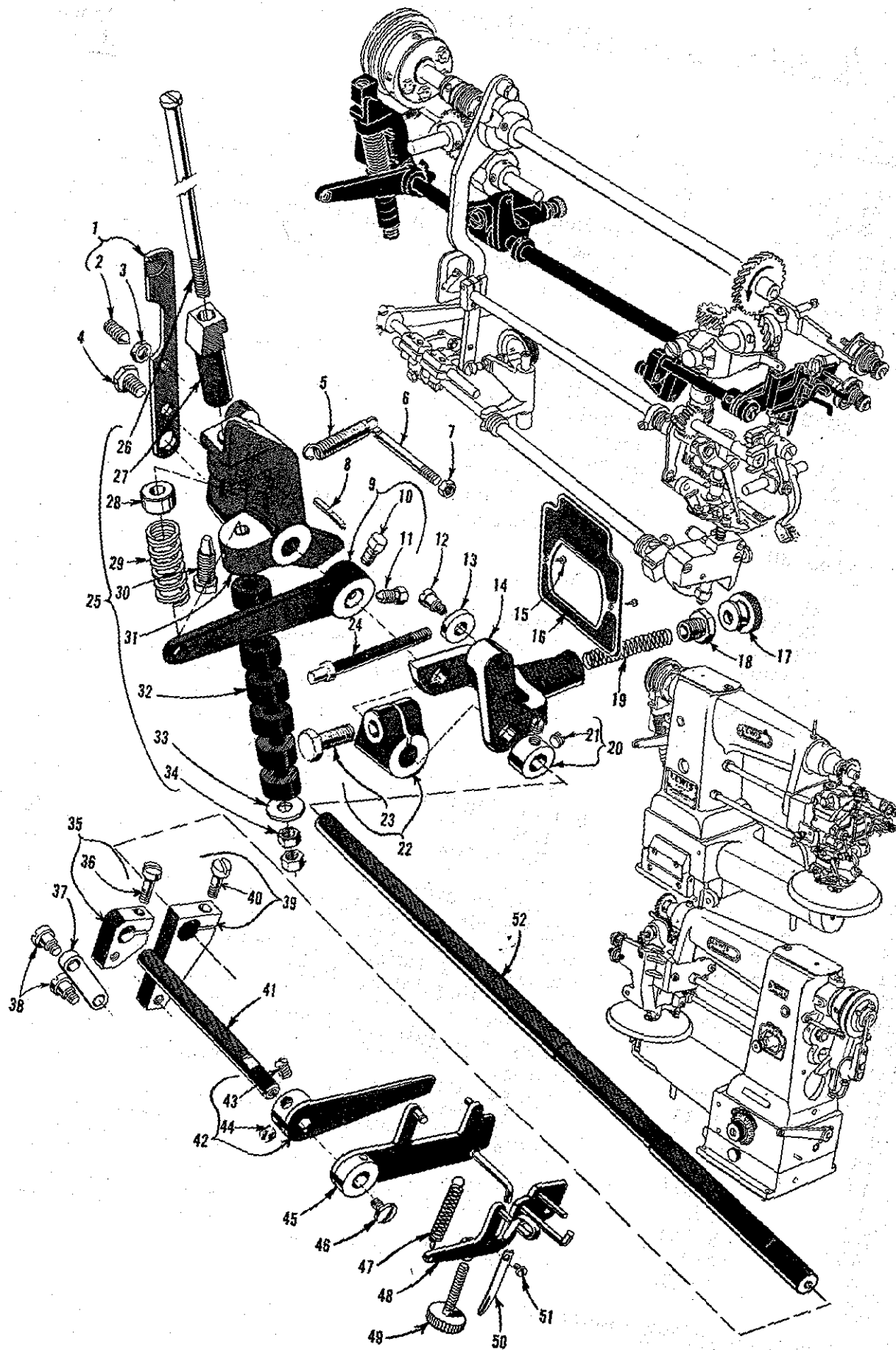

STOP MOTION, STITCH REGULATING AND THREAD PULL-OFF PARTS

<u>Ref. No.</u>	<u>Part No.</u>	<u>Description</u>	<u>Amt. Req.</u>
1	45-302	Lever for applying pressure on Pulley Clutch Disc -----	1
2	18-747	Spot Screw -----	1
3	20-34	Nut -----	1
4	18-280	Screw -----	1
5	21-360	Stop Motion Lever Restoring Spring -----	1
6	22-276	Stop Motion Lever Restoring Spring Pin -----	1
7	1009 L	Nut -----	1
8	22-266	Stop Motion Lever Restoring Spring Pin -----	1
9	45-362	Foot Pedal Chain Lever -----	1
10	18-120	Screw -----	1
11	1298 L	Screw -----	1
12	18-1105	Screw -----	1
13	35-28	Stitch Adjusting Lever Roll -----	1
14	45-360	Stitch Adjusting Lever -----	1
15	18-768	Drive Screw -----	2
16	97-18	Stitch Indicator Plate -----	1
17	1316 L	Stitch Selector Plunger Adjusting Nut -----	1
18	20-124	Stitch Selector Plunger Spring Retaining Nut -----	1
19	21-347	Stitch Selector Plunger Spring -----	1
20	439-7	Collar -----	1
21	SB15	Set Screw -----	2
22	115-135	Stitch Selecting Cam Block -----	1
23	18-978	Clamp Screw -----	1
24	426-166	Stitch Selector Plunger, complete -----	1
25	445-348-4	Stop Motion Lever, complete -----	1
26	71-92	Stop Motion Plunger Rod -----	1
27	26-163 A	Stop Motion Plunger -----	1
28	157-13	Stop Motion Spacer Collar -----	1
29	21-457	Stop Motion Spring -----	1
30	18-819	Screw -----	1
31	45-348	Stop Motion Plunger Lever -----	1
32	40-198	Washer -----	6
33	652-16	Washer -----	1
34	20-128	Nut -----	2
35	48-161	Thread Pull-off Crank, short -----	1
36	1073 L	Screw -----	1
37	46-167	Link for Thread Pull-off Crank -----	1
38	18-688	Screw -----	2
39	48-162	Thread Pull-off Crank, long -----	1
40	1073 L	Screw -----	1
41	14-466	Thread Pull-off Lever Shaft -----	1
42	445-397	Thread Pull-off Plunger Operating Lever, complete -----	1
43	1005 L	Set Screw -----	1
44	1025 L	Set Screw -----	1
45	445-398	Thread Pull-off Lever, complete -----	1
46	1329 L-1/2	Screw -----	1
47	21-390	Thread Pull-off Lever Spring -----	1
48	499-325	Thread Pull-off Pin Holder, complete -----	1
49	18-1005	Thread Pull-off Adjusting Screw -----	1
50	21-389	Thread Pull-off Adjusting Screw Retaining Spring -----	1
51	1075 L	Screw -----	1
52	14-467	Stop Motion Lever Shaft -----	1

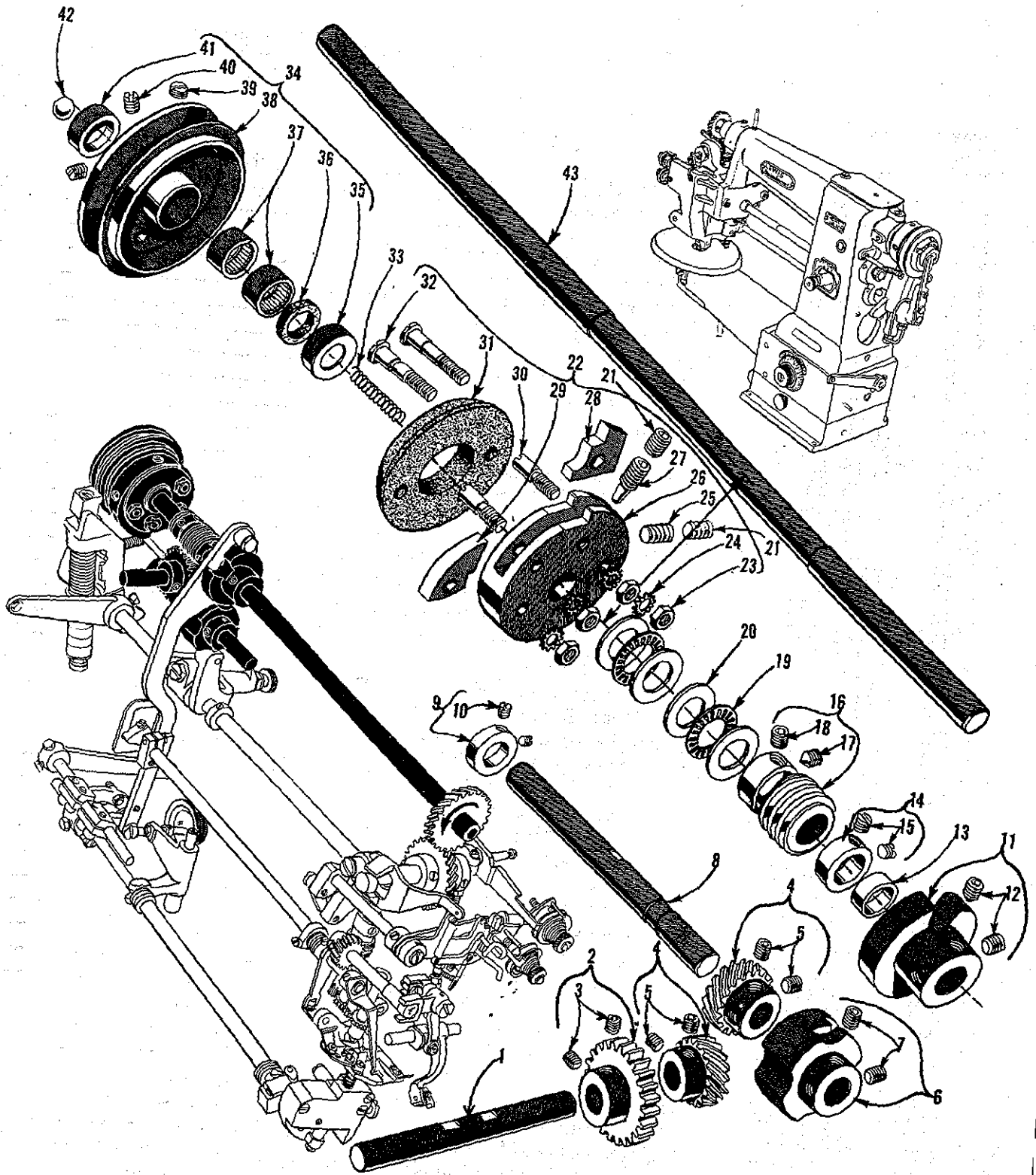

MAIN SHAFT, HANDWHEEL AND STOP MOTION DRIVE

<u>Ref. No.</u>	<u>Part No.</u>	<u>Description</u>	<u>Amt. Req.</u>
1	14-444	Jackshaft -----	1
2	27-185	Jackshaft Worm Gear -----	1
3	18-730	Set Screw -----	2
4	27-168	Spiral Gear -----	2
5	18-996	Set Screw -----	2
6	34-67	Stitch Tacking Cam -----	1
7	18-730	Set Screw -----	2
8	14-465	Camshaft -----	1
9	439-7	Collar -----	1
10	SB15	Set Screw -----	2
11	34-59	Plunger Raising Cam -----	1
12	18-730	Set Screw -----	2
13	35-30	Roll for Plunger Lifting Connecting Rod -----	1
14	39-92	Collar -----	1
15	1025 L	Set Screw -----	2
16	27-184	Main Shaft Worm Gear -----	1
17	18-976	Spot Screw -----	1
18	18-730	Set Screw -----	1
19	478-27	Needle Bearing -----	2
20	40-135	Washer -----	2
21	18-967	Set Screw -----	2
22	444-334	Stop Motion, complete -----	1
23	20-127	Nut -----	4
24	652 N-14	Washer -----	4
25	18-967	Set Screw -----	1
26	44-334	Stop Motion Disc -----	1
27	18-958	Stop Screw -----	1
28	166-7	Stop Motion Disc Pawl -----	1
29	51-20	Stop Motion Disc Latch -----	1
30	18-959	Screw -----	2
31	44-288	Pulley Clutch Disc -----	1
32	18-982	Screw -----	2
33	21-229	Spring -----	1
34	458-39	Pulley Assembly, complete -----	1
35	40-169	Retainer Washer -----	1
36	63-32	Grease Retainer -----	1
37	478-10	Needle Bearing -----	2
38	59-39	Pulley -----	1
39	18-800	Set Screw -----	1
40	1005 L	Set Screw -----	2
41	190-2 L	Pulley Insert -----	1
42	79-37	Ball -----	1
43	14-442	Main Shaft -----	1

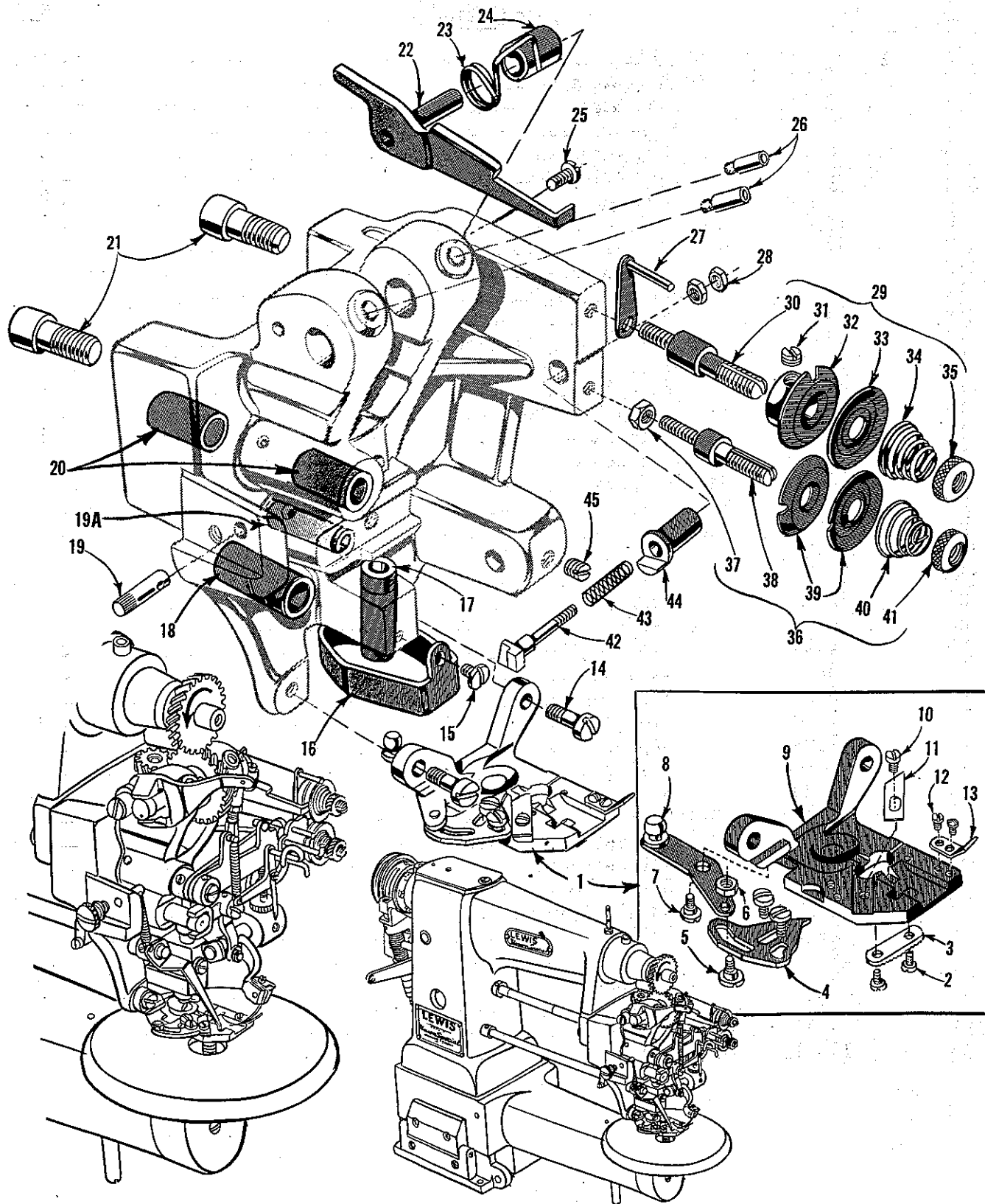

HEAD, PRESSER FOOT AND TENSION PARTS

<u>Ref. No.</u>	<u>Part No.</u>	<u>Description</u>	<u>Amt. Req.</u>
* 1	405-555	Presser Foot, complete, See Page No. 29 for other presser feet-----	1
2	18-983	Screw-----	2
3	6-65	Needle Guide-----	1
4	119-85	Thread Breaking Finger-----	1
5	18-1007	Screw-----	3
6	20-13	Nut-----	1
7	18-980	Screw-----	1
8	445-399	Thread Cutting Finger Operating Lever-----	1
9	5-555	Presser Foot, main section-----	1
10	1351 L	Screw-----	1
11	119-76	Thread Cutting Knife-----	1
12	18-621	Screw-----	2
13	8-130	Needle Guard-----	1
14	1073 L	Screw-----	2
15	CS337	Screw-----	1
16	32-233	Looper Gear Cover-----	1
17	16-328	Looper Driving Shaft Bushing-----	1
18	16-337	Trimmer Shaft Bushing, front-----	1
19	22-274	Thread Wiper Finger Spring Pin-----	1
19A	LS201	Needle Carrier Crankshaft Bushing-----	1
20	16-346	Thread Pull-off Lever Shaft Bushing-----	2
21	18-1045	Screw-----	2
22	445-367	Thread Tension Releasing Lever, complete-----	1
23	21-349	Tension Release Lever Spring-----	1
24	16-264	Thread Tension Releasing Lever Bushing-----	1
25	810 L	Screw-----	1
26	125-23	Oil Cup-----	2
27	4137-127	Nipper Retainer, complete-----	1
28	20-13	Nut-----	2
29	468-25	Thread Nipper Staff, complete-----	1
30	68-27	Tension Staff-----	1
31	1029 L	Set Screw-----	1
32	444-282	Tension Disc, complete-----	1
33	1183 L	Tension Disc-----	1
34	1132 SL	Tension Spring-----	1
35	20-60	Adjusting Nut-----	1
36	468-26	Thread Tension Staff, complete-----	1
37	1160 L	Nut-----	1
38	68-28	Tension Staff-----	1
39	1183 L	Tension Disc-----	2
40	21-284	Tension Spring-----	1
41	20-60	Adjusting Nut-----	1
42	26-171	Thread Pull-off Lever Retaining Plunger-----	1
43	21-339	Thread Pull-off Lever Retaining Plunger Spring-----	1
44	70-63	Thread Pull-off Lever Retaining Plunger Sleeve-----	1
45	1005 L	Set Screw-----	1

* Furnished with machine unless otherwise specified.

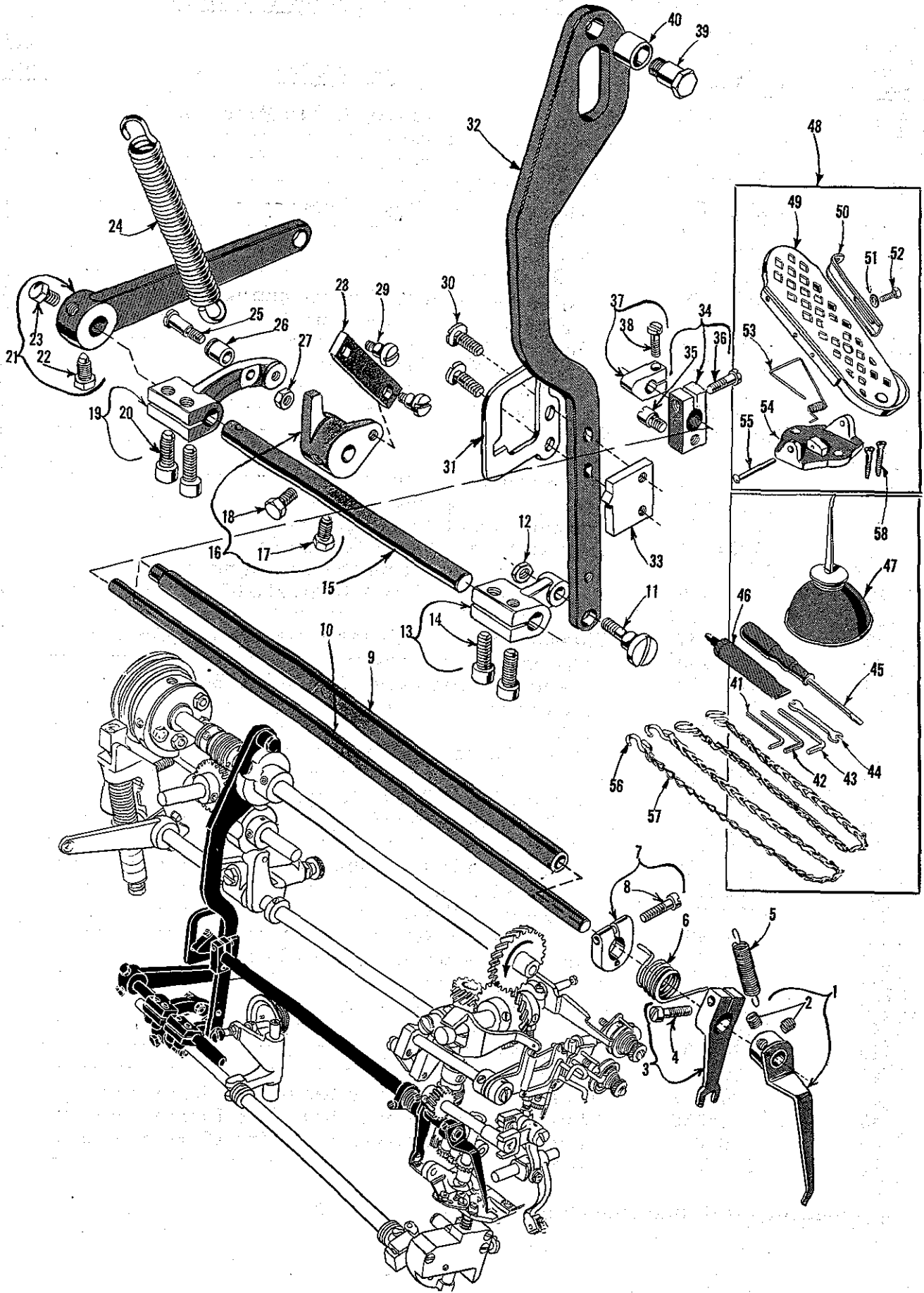

PLUNGER DEPRESSING AND THREAD WIPER FINGER
MECHANISM AND ACCESSORIES

Ref. No.	Part No.	Description	Amt. Req.
1	4122-41	Thread Wiper Finger, complete	1
2	1025 L	Set Screw	2
3	48-156	Trimmer Lever Operating Crank	1
4	18-40	Clamp Screw	1
5	21-319	Thread Wiper Finger Spring	1
6	21-380	Trimmer Knife Operating Spring	1
7	30-64	Trimmer Spring Clamp	1
8	18-40	Clamp Screw	1
9	14-459	Trimmer Shaft	1
10	14-460	Thread Wiper Shaft	1
11	18-990	Screw	1
12	1012 L	Nut	1
13	48-160	Plunger Restoring Crank	1
14	18-998	Clamp Screw	2
15	14-461	Plunger Lifting Rod Jackshaft	1
16	48-146	Plunger Depressing Crank	1
17	18-690	Spot Screw	1
18	18-493	Screw	1
19	48-159	Plunger Depressing Differential Crank	1
20	18-998	Clamp Screw	2
21	45-364	Plunger Depressing Lever	1
22	18-690	Spot Screw	1
23	1333 L	Screw	1
24	21-206	Plunger Restoring Spring	1
25	18-408	Screw	1
26	35-24	Plunger Restoring Spring Stud Roll	1
27	1160 L	Nut	1
28	46-137	Link	1
29	18-688	Screw	2
30	FP505	Screw	2
31	110-375	Thread Wiper Operating Cam Plate	1
32	47-127	Plunger Lifting Connecting Rod	1
33	34-64	Automatic Thread Trimmer Cam	1
34	48-163	Thread Breaking Finger Operating Crank	1
35	18-901	Screw	1
36	18-375	Clamp Screw	1
37	48-172	Thread Wiper Crank	1
38	1750 L	Clamp Screw	1
39	18-991	Screw	1
40	35-29	Plunger Lifting Rod Roll	1
41	WR56	Wrench, 1/8 inch hexagon	1
42	WR57	Wrench, 5/32 inch hexagon	1
43	WR58	Wrench, 3/16 inch hexagon	1
44	1405 L	Double End Wrench, 1/4 inch and 5/16 inch opening	1
45	21201	Screwdriver, 9/64 inch round blade, overall length 7 11/16 inches	1
46	28604 P	Grease Tube	1
47	413 D	Oil Can	1
† 48	4135-9	Foot Treadle, complete	2
49	135-9	Foot Treadle, main section	1
50	45-424	Lever	1
51	40-181	Washer	1
52	18-1033	Screw	1
53	21-408	Spring	1
54	50-265	Bracket	1
55	43-27	Rivet	1
56	131-C163-1	"S" Hook	4
57	130-10	Foot Treadle Chain	2
58	1504 L	Wood Screw (#14 x 3/4 inch)	4
*	18-955	Stove Bolt, 1/4 - 20 thread, 3 inches long	4
*	652-16	Washer, for stove bolt	4

† Not furnished with machine, but will be furnished gratis upon request with machine order.

* For attaching machine to tableboard, not shown on picture plate.

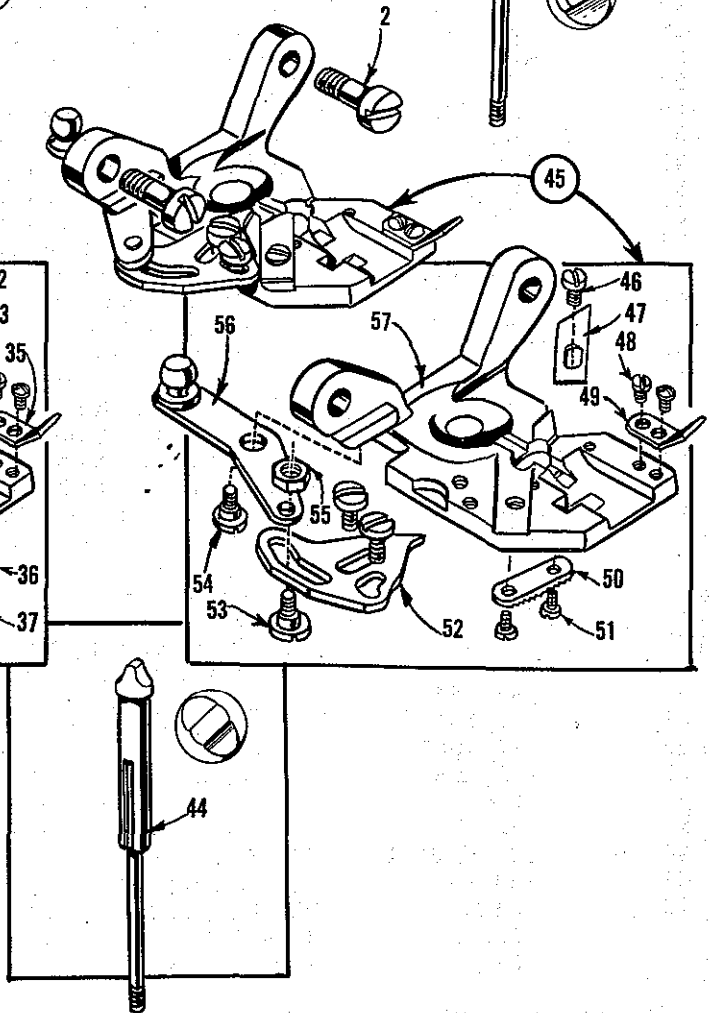
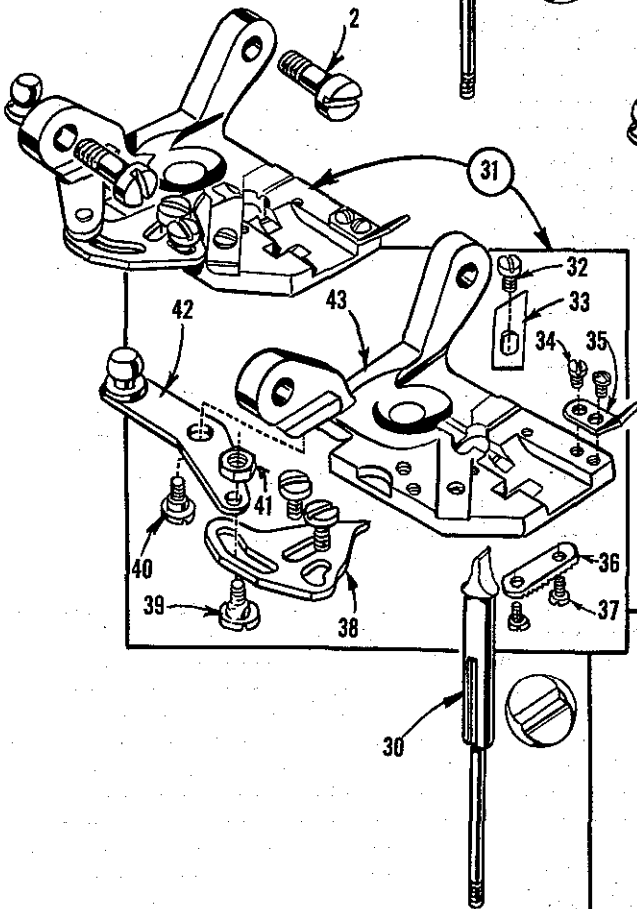
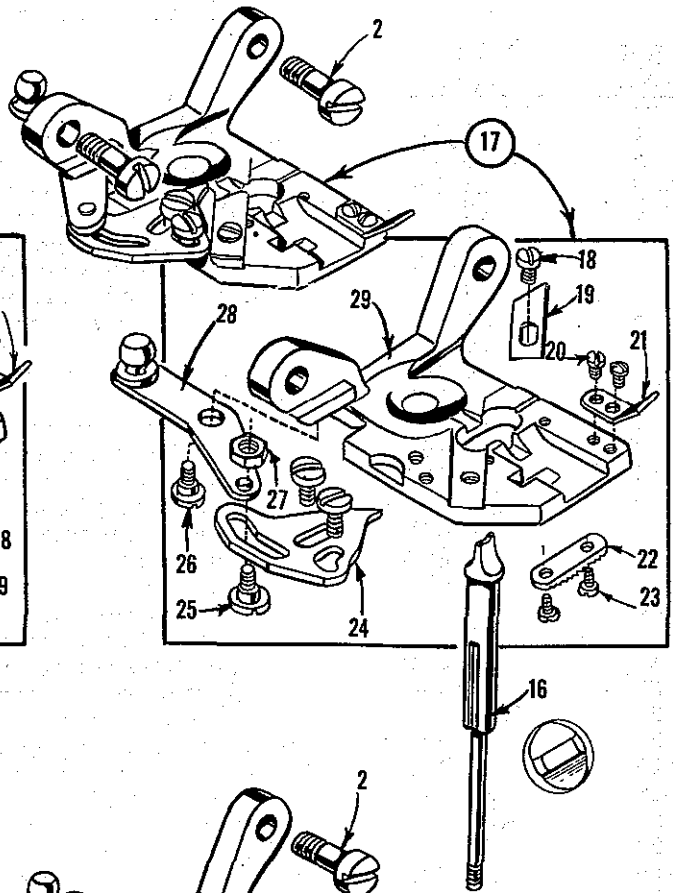
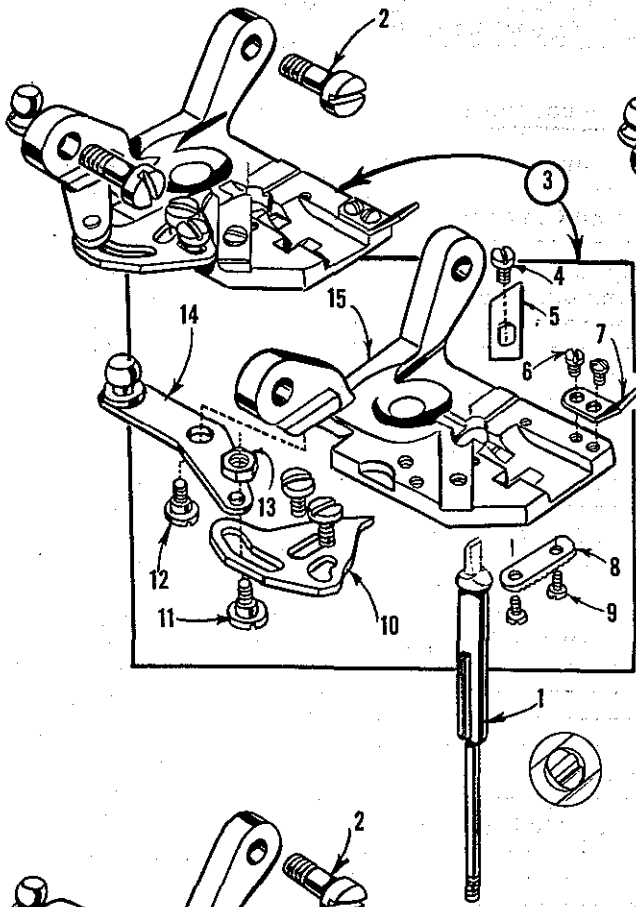

PRESSER FEET AND PLUNGERS

<u>Ref. No.</u>	<u>Part No.</u>	<u>Description</u>	<u>Amt. Req.</u>
<u>Alternate Combination for Heavy and Extra Heavy Weight Material</u>			
1	26-172	Plunger, for extra heavy weight material-----	1
	26-173	Plunger, for heavy weight material, see Ref. No. 16-----	1
2	1073 L	Screw, for presser foot-----	2
3	405-555 H	Presser Foot, complete-----	1
4	1351 L	Screw-----	1
5	119-76	Thread Cutting Knife-----	1
6	18-621	Screw-----	2
7	8-130	Needle Guard-----	1
8	6-65	Needle Guide-----	1
9	18-983	Screw-----	2
10	119-85	Thread Breaking Finger-----	1
11	18-1007	Screw-----	3
12	18-980	Screw-----	1
13	20-13	Lock Nut-----	1
14	445-399	Thread Cutting Finger Operating Lever-----	1
15	5-555 H	Presser Foot, main section-----	1
<u>Standard Combination for Medium Weight Material</u>			
16	26-173	Plunger-----	1
17	405-555	Presser Foot, complete-----	1
18	1351 L	Screw-----	1
19	119-76	Thread Cutting Knife-----	1
20	18-621	Screw-----	2
21	8-130	Needle Guard-----	1
22	6-65	Needle Guide-----	1
23	18-983	Screw-----	2
24	119-85	Thread Breaking Finger-----	1
25	18-1007	Screw-----	3
26	18-980	Screw-----	1
27	20-13	Lock Nut-----	1
28	445-399	Thread Cutting Finger Operating Lever-----	1
29	5-555	Presser Foot, main section-----	1
<u>Alternate Combination for Light Weight Material</u>			
30	26-170	Plunger-----	1
31	405-554	Presser Foot, complete-----	1
32	1351 L	Screw-----	1
33	119-76	Thread Cutting Knife-----	1
34	18-621	Screw-----	2
35	8-130	Needle Guard-----	1
36	6-61	Needle Guide-----	1
37	18-983	Screw-----	2
38	119-85	Thread Breaking Finger-----	1
39	18-1007	Screw-----	3
40	18-980	Screw-----	1
41	20-13	Lock Nut-----	1
42	445-399	Thread Cutting Finger Operating Lever-----	1
43	5-554	Presser Foot, main section-----	1
<u>Alternate Combination for Tacking Labels and Light Weight Material</u>			
44	26-174	Plunger, for tacking labels-----	1
	26-170	Plunger, for light weight material, see Ref. No. 30-----	1
45	405-554 L	Presser Foot, complete-----	1
46	1351 L	Screw-----	1
47	119-76	Thread Cutting Knife-----	1
48	18-621	Screw-----	2
49	8-130	Needle Guard-----	1
50	6-61	Needle Guide-----	1
51	18-983	Screw-----	2
52	119-85	Thread Breaking Finger-----	1
53	18-1007	Screw-----	3
54	18-980	Screw-----	1
55	20-13	Lock Nut-----	1
56	445-399	Thread Cutting Finger Operating Lever-----	1
57	5-554 L	Presser Foot, main section-----	1

NUMERICAL INDEX OF PARTS

<u>Part No.</u>	<u>Page No.</u>	<u>Part No.</u>	<u>Page No.</u>	<u>Part No.</u>	<u>Page No.</u>
3-91.....	15	18-624.....	17	21-403.....	19
4-134.....	15	18-688.....	21,27	21-404.....	19
5-554.....	29	18-690.....	27	21-408.....	27
5-554 L.....	29	18-730.....	23	21-457.....	21
5-555.....	25,29	18-747.....	21	22-148.....	15
5-555 H.....	29	18-768.....	19,21	GR-22C214-2.....	15
6-61.....	29	18-800.....	23	GR-22C214-4.....	19
6-65.....	25,29	18-819.....	21	22-266.....	21
8-126.....	21	18-901.....	27	22-274.....	25
8-130.....	25,29	18-949.....	17	22-275.....	15
8-150.....	15	18-958.....	23	22-276.....	21
14-442.....	23	18-959.....	15,23	22-296.....	19
14-444.....	23	18-967.....	23	22-297.....	19
14-446.....	19	18-976.....	23	26-163 A.....	21
14-447.....	17	18-978.....	21	26-170.....	29
14-448.....	17	18-979.....	15	26-171.....	25
14-459.....	27	18-980.....	25,29	26-172.....	29
14-460.....	27	18-982.....	23	26-173.....	29
14-461.....	27	18-983.....	25,29	26-174.....	29
14-465.....	23	18-990.....	27	27-168.....	23
14-466.....	21	18-991.....	27	27-184.....	23
14-467.....	21	18-993.....	15	27-185.....	23
14-472.....	19	18-994.....	17	27-186.....	17
14-508.....	15	18-996.....	23	27-187.....	17
SB15.....	21,23	18-998.....	15,27	27-188.....	17
16-264.....	25	18-1005.....	21	30-64.....	27
16-323.....	15	18-1007.....	25,29	30-65.....	19
16-324.....	15	18-1026.....	19	32-233.....	25
16-325.....	15	18-1027.....	19	32-265.....	15
16-326.....	15	18-1028.....	19	32-266.....	15
16-328.....	25	18-1030.....	15	32-275.....	15
16-333.....	15	18-1033.....	27	34-59.....	23
16-337.....	25	18-1045.....	15,25	34-64.....	27
16-338.....	15	18-1094.....	17	34-67.....	23
16-343.....	15	18-1105.....	21	35-24.....	27
16-344.....	15	20-13.....	25,29	35-26.....	17
16-345.....	15	20-34.....	19,21	35-28.....	21
16-346.....	25	20-60.....	25	35-29.....	27
16-352.....	19	20-124.....	21	35-30.....	23
16-354.....	15	20-127.....	23	36-19.....	17
16-366.....	19	20-128.....	21	39-92.....	23
16-379.....	15	20-130.....	15	39-95.....	17
16-382.....	17	21-206.....	27	40-17.....	17
17-137.....	17	21-229.....	23	40-57.....	17
17-167.....	15	21-237.....	19	40-135.....	23
17-175.....	17	21-284.....	25	40-139.....	15
17-176.....	15	21-319.....	27	40-169.....	23
18-40.....	27	21-339.....	25	40-181.....	27
18-120.....	21	21-347.....	21	40-198.....	21
18-280.....	21	21-349.....	25	41-28.....	17
18-375.....	27	21-360.....	21	41-55.....	15
18-391.....	17	21-380.....	27	43-27.....	27
18-408.....	27	21-381.....	15	44-288.....	23
18-416.....	19	21-383.....	19	44-301.....	19
18-493.....	27	21-389.....	21	44-334.....	23
18-619.....	17	21-390.....	21	45-302.....	21
18-621.....	25,29	21-402.....	19	45-348.....	21

NUMERICAL INDEX OF PARTS

<u>Part No.</u>	<u>Page No.</u>	<u>Part No.</u>	<u>Page No.</u>	<u>Part No.</u>	<u>Page No.</u>
45-360.....	21	147-10.....	15	1025 L.....	27
45-362.....	21	157-13.....	21	1027 L.....	17,19
45-364.....	27	166-7.....	23	1029 L.....	17,19,25
45-424.....	27	190-2 L.....	23	1036 L.....	17
46-137.....	27	LS201.....	25	1073 L.....	21,25,29
46-146.....	17	CS313.....	15	1075 L.....	21
46-167.....	21	CS320-1/2.....	15	1132 SL.....	25
47-127.....	27	CS327.....	17	1137 L.....	19
48-146.....	27	CS337.....	25	1160 L.....	15,25,27
48-154.....	17	LS395.....	15	1173 L.....	19
48-156.....	27	405-554.....	29	1183 L.....	25
48-159.....	27	405-554 L.....	29	1192 L.....	19
48-160.....	27	405-555.....	25,29	1195 L.....	15
48-161.....	21	405-555 H.....	29	1196 L.....	15
48-162.....	21	408-150.....	15	1203 L.....	17
48-163.....	27	413 D.....	27	1219 L.....	15
48-165.....	19	418-1026.....	19	1220 L.....	15
48-166.....	19	426-166.....	21	1221 L.....	15
48-168.....	19	439-7.....	21,23	1279 L.....	19
48-172.....	27	444-282.....	25	1298 L.....	19,21
50-262.....	15	444-334.....	23	1304 L.....	19
50-263 L.....	15	445-348-4.....	21	1306 L.....	19
50-265.....	27	445-366.....	17	1311 L.....	15,17,19
50-319.....	15	445-367.....	25	1316 L.....	21
51-20.....	23	445-397.....	21	1329 L-1/2.....	21
GR-51-26.....	15	445-398.....	21	1333 L.....	27
WR56.....	27	445-399.....	25,29	1351 L.....	25,29
WR57.....	27	447-23.....	17	1405 L.....	27
58-39.....	23	447-128.....	17	1420 L.....	17
WR58.....	27	458-39.....	23	1432 AL.....	17
61-76.....	15	468-25.....	25	1504 L.....	27
61-82.....	19	468-26.....	25	1717 L.....	17
63-32.....	23	478-10.....	23	1718 L.....	17
68-27.....	25	478-11.....	19	1719 L.....	17
68-28.....	25	478-23.....	19	1750 L.....	27
69-18.....	17	478-27.....	23	1762 L.....	17
70-61.....	17	499-325.....	21	1763 L.....	17
70-63.....	25	FP505.....	27	1804 L.....	17
70-77.....	15	651-20.....	15	4115-134-2.....	19
71-92.....	21	652-16.....	21	4121-5.....	19
71-95.....	17	652-20.....	15	4122-41.....	27
79-31.....	19	652 N-14.....	23	4124-57.....	17
79-37.....	23	652 A-20.....	15	4135-9.....	27
97-18.....	21	660-615.....	15	4137-127.....	25
108-9.....	15	667 B-20.....	15	GR-4149-30.....	19
110-323.....	19	782 L.....	17	12957 E.....	15
110-375.....	27	810 L.....	25	21201.....	27
115-122.....	19	854 L.....	15	21261 M-440.....	15
115-135.....	21	869 L.....	17	21697 AE.....	15
115-139.....	19	1005 L.....	17,19,21,23,25	21697 AF-32.....	15
118-34.....	17	1009 L.....	21	22642 K-32.....	15
119-76.....	25,29	1012 L.....	17,27	22642 K-48.....	15
119-85.....	25,29	1014 L.....	17	22845 D.....	15
125-23.....	15,25	1016 L.....	17	28602 AS-18.....	15
130-10.....	27	1022 L.....	17	28604 P.....	27
131-C163-1.....	27	1025 L.....	17,21,23,	28741 H.....	15
135-9.....	27			51242 M.....	17

Union Special Corporation
Corporate Office
One Union Special Plaza
Huntley, IL 60142
Phone: 847•669•5101
Fax: 847•669•4454

Union Special GmbH
European Distribution Center
Raiffeisenstrasse 3
D-71696 Möglingen, Germany
Tel: 49•07141•247•0
Fax: 49•07141•247•100

JUKI CORPORATION
INTERNATIONAL SALES DIVISION
8-2-1, KOKURYO - CHO,
CHOFU-SHI, TOKYO 182, JAPAN
PHONE: 03(3430)4001~5
FAX: 03(3430)4909 . 4914 . 4984



Union Special
INDUSTRIAL SEWING EQUIPMENT